

80V N-Ch Power MOSFET

V_{DS}		80	V
$R_{DS(on),typ}$	$V_{GS}=10V$	9.5	m
$R_{DS(on),typ}$	$V_{GS}=4.5V$	13.5	m
I_D (Silicon Limited)		50	A

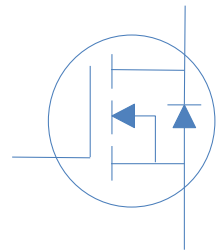
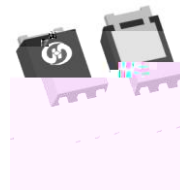
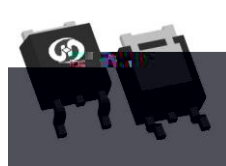

Part Number	Package	Marking
HGD110N08AL	TO-252	GD110N08AL
HGI110N08AL	TO-251	GI110N08AL

Absolute Maximum Ratings at $T_J=25^\circ\text{C}$ (unless otherwise specified)

Parameter	Symbol	Conditions	Value	Unit
Continuous Drain Current (Silicon Limited)	I_D	$T_C=25^\circ\text{C}$	50	A
		$T_C=100^\circ\text{C}$	36	
Drain to Source Voltage	V_{DS}	-	80	V
Gate to Source Voltage	V_{GS}	-	± 20	V
Pulsed Drain Current	I_{DM}	-	250	A
Avalanche Energy, Single Pulse	E_{AS}	$L=0.4\text{mH}, T_C=25^\circ\text{C}$	45	mJ
Power Dissipation	P_D	$T_C=25^\circ\text{C}$	63	W
Operating and Storage Temperature	T_J, T_{stg}	-	-55 to 175	$^\circ\text{C}$

Absolute Maximum Ratings

Parameter	Symbol	Max	Unit
Thermal Resistance Junction-Ambient	R_{JA}	50	$^\circ\text{C/W}$
Thermal Resistance Junction-Case	R_{JC}	2.4	$^\circ\text{C/W}$

Electrical Characteristics at $T_J=25^{\circ}\text{C}$ (unless otherwise specified)
Static Characteristics

Parameter	Symbol	Conditions	Value			Unit
			min	typ	max	
Drain to Source Breakdown Voltage	$V_{(BR)DSS}$	$V_{GS}=0V, I_D=250\text{ A}$	80	-	-	V
Gate Threshold Voltage	$V_{GS(th)}$	$V_{GS}=V_{DS}, I_D=250\text{ A}$	1.0	1.9	2.4	
Zero Gate Voltage Drain Current	I_{DSS}	$V_{GS}=0V, V_{DS}=80V, T_J=25^{\circ}\text{C}$	-	-	1	A
		$V_{GS}=0V, V_{DS}=80V, T_J=100^{\circ}\text{C}$	-	-	100	
Gate to Source Leakage Current	I_{GSS}	$V_{GS}=\pm 20V, V_{DS}=0V$	-	-	± 100	nA
Drain to Source on Resistance	$R_{DS(on)}$	$V_{GS}=10V, I_D=10A$	-	9.5	11.5	m
Drain to Source on Resistance	$R_{DS(on)}$	$V_{GS}=4.5V, I_D=5A$	-	13.5	16	m
Transconductance	g_{fs}	$V_{DS}=5V, I_D=10A$	-	40	-	S
Gate Resistance	R_G	$V_{GS}=0V, V_{DS}\text{ Open}, f=1\text{MHz}$	-	1.3	-	

Dynamic Characteristics

Input Capacitance	C_{iss}	$V_{GS}=0V, V_{DS}=40V, f=1\text{MHz}$	-	1131	-	pF
Output Capacitance	C_{oss}		-	205	-	
Reverse Transfer Capacitance	C_{rss}		-	8.5	-	
Total Gate Charge	$Q_g(10V)$	$V_{DD}=40V, I_D=10A, V_{GS}=10V$	-	23	-	nC
Total Gate Charge	$Q_g(4.5V)$		-	12.5	-	
Gate to Source Charge	Q_{gs}		-	3	-	
Gate to Drain (Miller) Charge	Q_{gd}		-	6	-	
Turn on Delay Time	$t_{d(on)}$	$V_{DD}=40V, I_D=10A, V_{GS}=10V, R_G=10\text{ }\Omega$	-	8	-	ns
Rise time	t_r		-	3	-	
Turn off Delay Time	$t_{d(off)}$		-	22	-	
Fall Time	t_f		-	4	-	

Reverse Diode Characteristics

Diode Forward Voltage	V_{SD}	$V_{GS}=0V, I_F=20A$	-	0.9	1.2	V
Reverse Recovery Time	t_{rr}	$V_R=40V, I_F=10A, dI_F/dt=100A/\text{s}$	-	35	-	ns
Reverse Recovery Charge	Q_{rr}		-	30	-	nC

Fig 1. Typical Output Characteristics

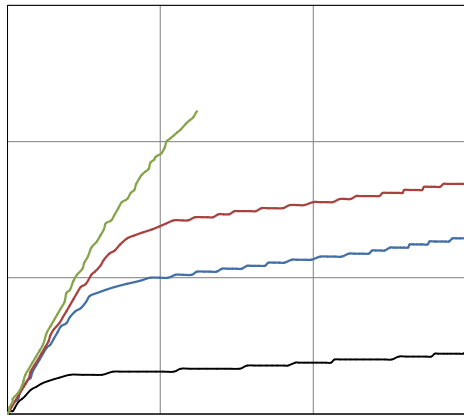

Figure 2. On-Resistance vs. Gate-Source Voltage

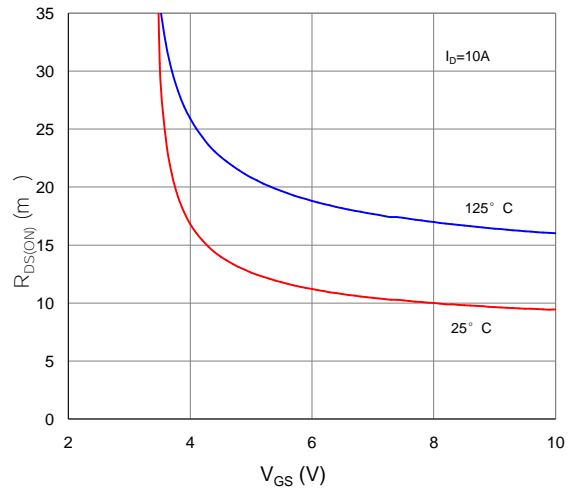

Figure 3. On-Resistance vs. Drain Current and Gate Voltage

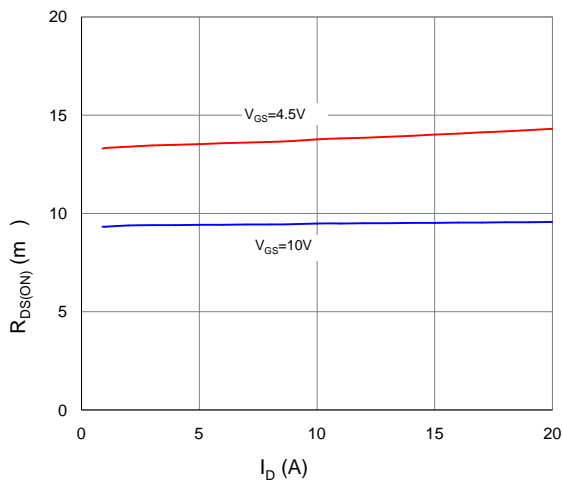

Figure 4. Normalized On-Resistance vs. Junction Temperature

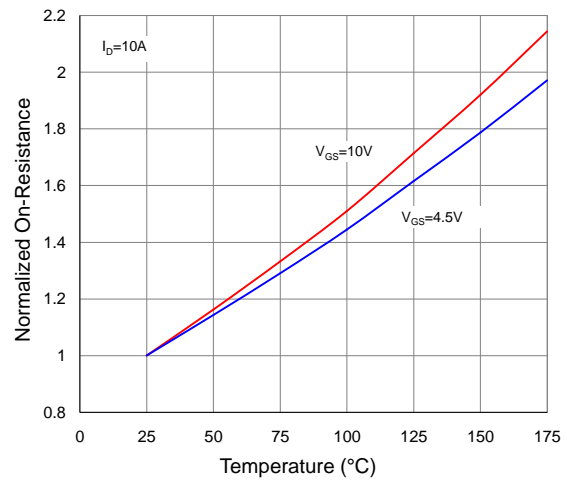

Figure 5. Typical Transfer Characteristics

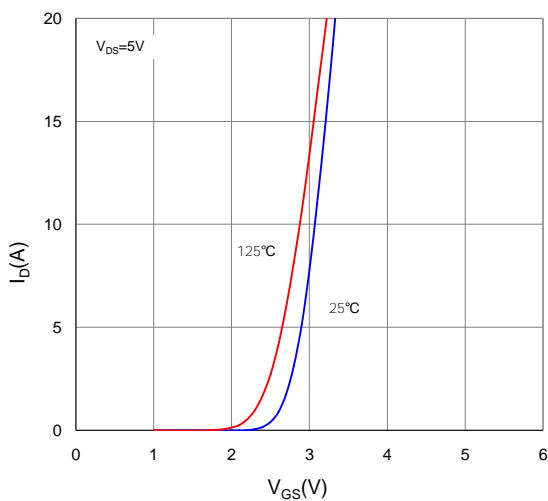

Figure 6. Typical Source-Drain Diode Forward Voltage

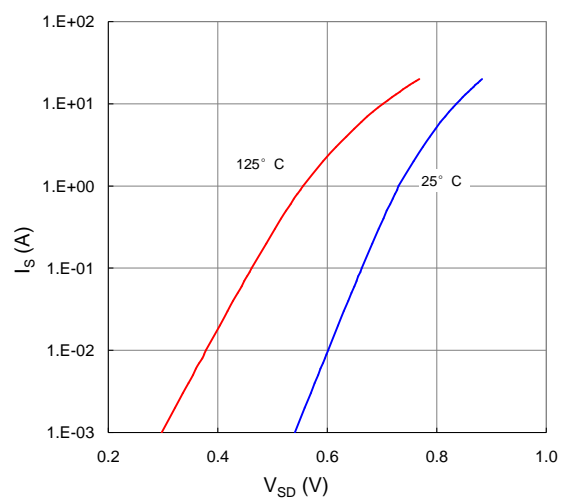

Figure 7. Typical Gate-Charge vs. Gate-to-Source Voltage

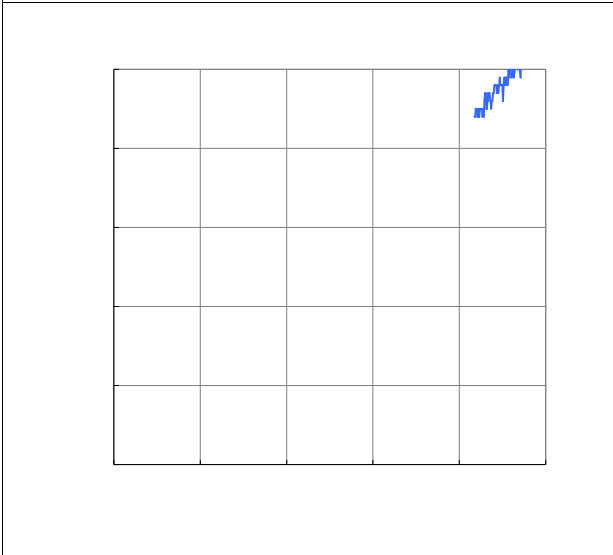

Figure 8. Typical Capacitance vs. Drain-to-Source Voltage

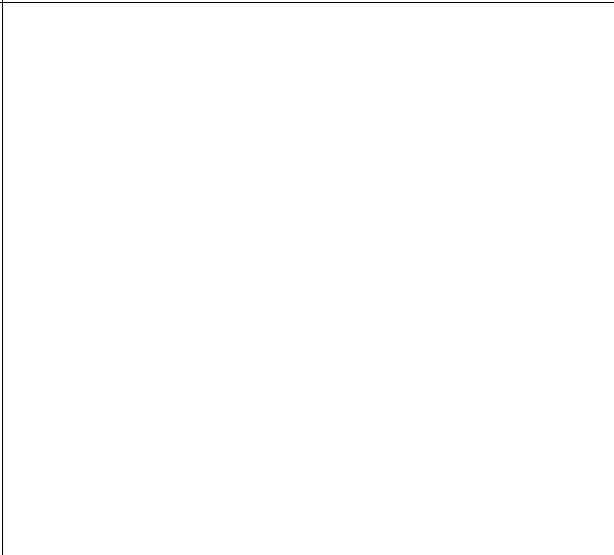

Figure 9. Maximum Safe Operating Area

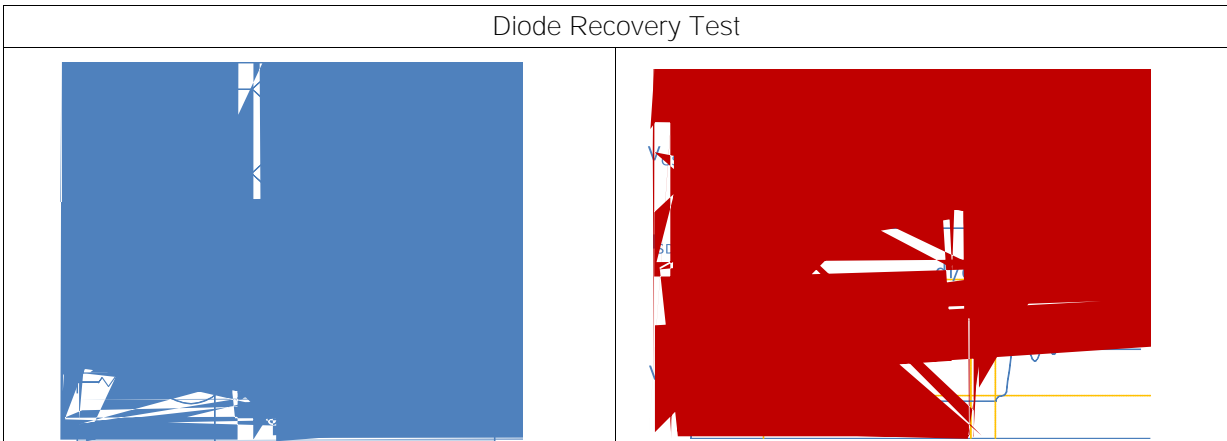
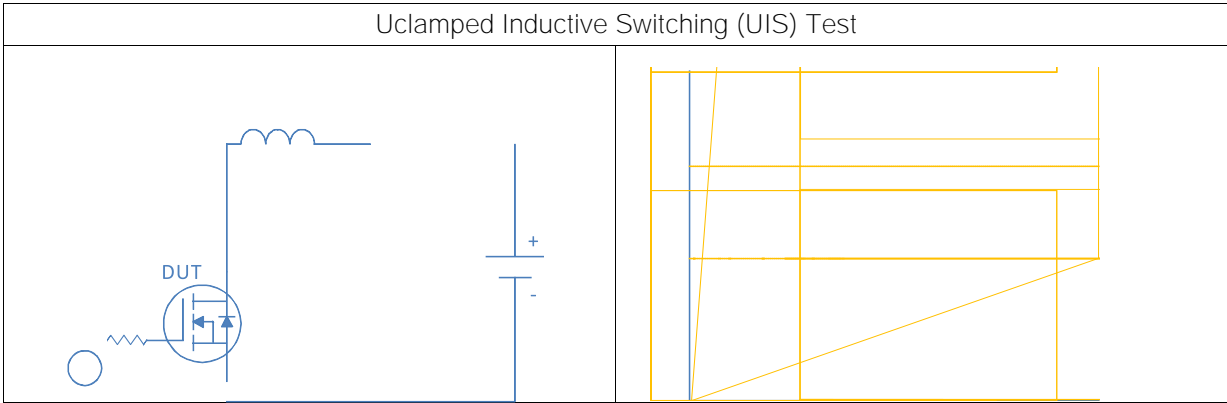
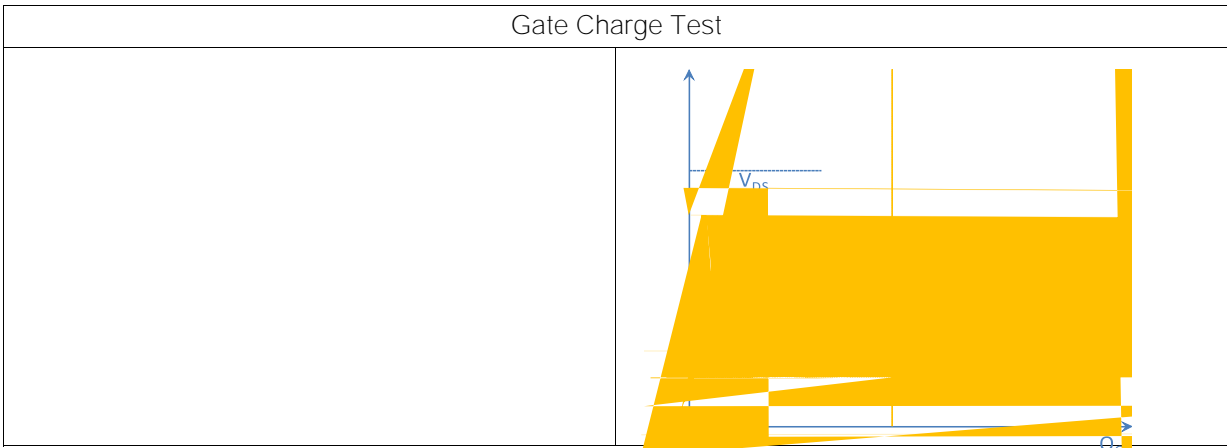
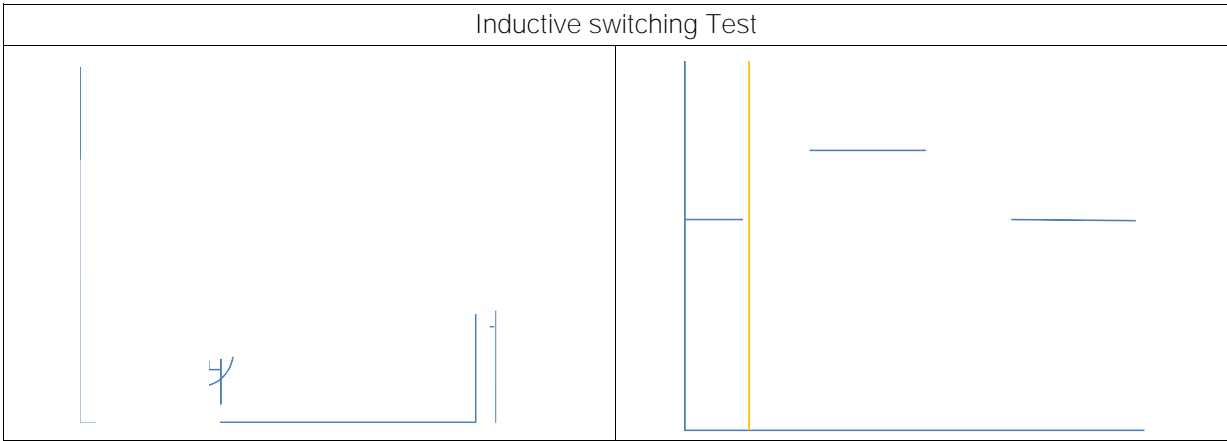

Figure 10. Maximum Drain Current vs. Case Temperature



Figure 11. Normalized Maximum Transient Thermal Impedance, Junction-to-Ambient





Package Outline

TO-252, 2 leads

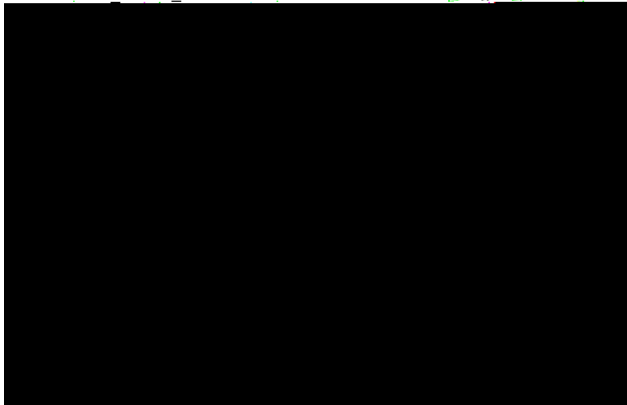

SYMBOL	DIMENSIONAL REQMTS		
	MIN	NOM	MAX
E	6.40	6.60	6.731
L	1.40	1.52	1.77
L1	2.743 REF		
L2	0.508 BSC		
L3	0.89	--	1.27
L4	0.64	--	1.01
L5	--	--	--
D	6.00	6.10	6.223
IF	0.35	0.00	0.00
Ik	0.00	0.00	0.00
IK1	0.77	0.00	0.00
IK2	0.00	0.00	0.00
IK3	0.00	0.00	0.00
IK4	0.00	0.00	0.00
IK5	0.00	0.00	0.00
IK6	0.00	0.00	0.00
IK7	0.00	0.00	0.00
IK8	0.00	0.00	0.00
IK9	0.00	0.00	0.00
IK10	0.00	0.00	0.00
IK11	0.00	0.00	0.00
IK12	0.00	0.00	0.00
IK13	0.00	0.00	0.00
IK14	0.00	0.00	0.00
IK15	0.00	0.00	0.00
IK16	0.00	0.00	0.00
IK17	0.00	0.00	0.00
IK18	0.00	0.00	0.00
IK19	0.00	0.00	0.00
IK20	0.00	0.00	0.00
IK21	0.00	0.00	0.00
IK22	0.00	0.00	0.00
IK23	0.00	0.00	0.00
IK24	0.00	0.00	0.00
IK25	0.00	0.00	0.00
IK26	0.00	0.00	0.00
IK27	0.00	0.00	0.00
IK28	0.00	0.00	0.00
IK29	0.00	0.00	0.00
IK30	0.00	0.00	0.00
IK31	0.00	0.00	0.00
IK32	0.00	0.00	0.00
IK33	0.00	0.00	0.00
IK34	0.00	0.00	0.00
IK35	0.00	0.00	0.00
IK36	0.00	0.00	0.00
IK37	0.00	0.00	0.00
IK38	0.00	0.00	0.00
IK39	0.00	0.00	0.00
IK40	0.00	0.00	0.00
IK41	0.00	0.00	0.00
IK42	0.00	0.00	0.00
IK43	0.00	0.00	0.00
IK44	0.00	0.00	0.00
IK45	0.00	0.00	0.00
IK46	0.00	0.00	0.00
IK47	0.00	0.00	0.00
IK48	0.00	0.00	0.00
IK49	0.00	0.00	0.00
IK50	0.00	0.00	0.00
IK51	0.00	0.00	0.00
IK52	0.00	0.00	0.00
IK53	0.00	0.00	0.00
IK54	0.00	0.00	0.00
IK55	0.00	0.00	0.00
IK56	0.00	0.00	0.00
IK57	0.00	0.00	0.00
IK58	0.00	0.00	0.00
IK59	0.00	0.00	0.00
IK60	0.00	0.00	0.00
IK61	0.00	0.00	0.00
IK62	0.00	0.00	0.00
IK63	0.00	0.00	0.00
IK64	0.00	0.00	0.00
IK65	0.00	0.00	0.00
IK66	0.00	0.00	0.00
IK67	0.00	0.00	0.00
IK68	0.00	0.00	0.00
IK69	0.00	0.00	0.00
IK70	0.00	0.00	0.00
IK71	0.00	0.00	0.00
IK72	0.00	0.00	0.00
IK73	0.00	0.00	0.00
IK74	0.00	0.00	0.00
IK75	0.00	0.00	0.00
IK76	0.00	0.00	0.00
IK77	0.00	0.00	0.00
IK78	0.00	0.00	0.00
IK79	0.00	0.00	0.00
IK80	0.00	0.00	0.00
IK81	0.00	0.00	0.00
IK82	0.00	0.00	0.00
IK83	0.00	0.00	0.00
IK84	0.00	0.00	0.00
IK85	0.00	0.00	0.00
IK86	0.00	0.00	0.00
IK87	0.00	0.00	0.00
IK88	0.00	0.00	0.00
IK89	0.00	0.00	0.00
IK90	0.00	0.00	0.00
IK91	0.00	0.00	0.00
IK92	0.00	0.00	0.00
IK93	0.00	0.00	0.00
IK94	0.00	0.00	0.00
IK95	0.00	0.00	0.00
IK96	0.00	0.00	0.00
IK97	0.00	0.00	0.00
IK98	0.00	0.00	0.00
IK99	0.00	0.00	0.00
IK100	0.00	0.00	0.00

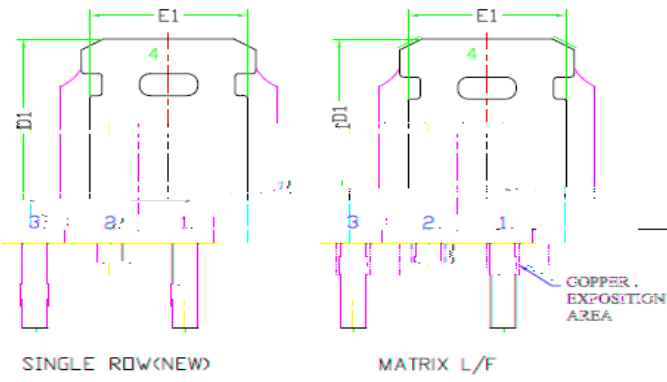

Package Outline

TO-251, 3leads

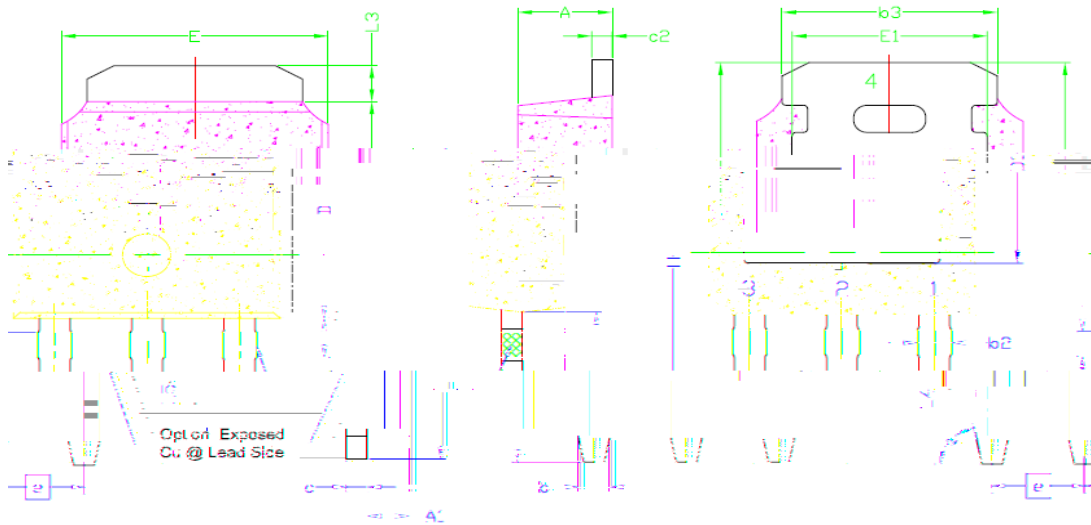

SYMBOL	DIMENSIONAL REQMTS		
	MIN	NOM	MAX
E	6.40	6.60	6.731
L	3.98	4.13	4.28
L3	0.89	--	1.27
L4	0.698 REF		
L5	0.972	1.099	1.226
D	6.00	6.10	6.223
H	11.05	11.25	11.45
b	0.64	0.76	0.88
b2	0.77	0.84	1.14
b3	5.21	5.34	5.46
e	2.286 BSC		
A	2.20	2.30	2.38
A1	0.89	1.04	1.15
c	0.46	0.50	0.60
c2	0.46	0.50	0.60
D1	5.10	--	--
E1	4.40	--	--
a	79° REF		